

CHAMELEON R4 PINHOLE ADJUSTABLE

ZOOMABLE

Trimless

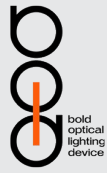

Key Features:

- Up to 1025lm delivered output
- Gear driven tilt 0° to 30° and 360° lockable rotation
- Various beams available upon request of vertical plane
- 5 years limited warranty
- Chicago plenum rated
- Zoomable Lens from 15° to 50°



Technical Data:

Body Material	Die-cast	Delivered Lumen Range	505 lm to 1025 lm
Safety	Chicago Plenum	Output Type	Constant Current
Warranty	5 Years	Driver	Integral
Light Source	COB	Code Compliance	CCEA / CCC / CSA / CE / ETL / JA8
Lifetime	L80/B10 @ 70,000 hours	CCT	2700K / 3000K / 3500K / 4000K / Tunable White / Dim to Warm / RGBW
Power Range	10W to 22W		

Housing Code :

Code Example: C4HR0LU0R9

C4HR0	Power	Voltage	Control	Housing	Emergency
C4HR0	Mono:	1	0	R	N
	L	120V	Non-Dim	Remodel	No
	U	Universal 120 to 277V	0-10 to 1%	Non-IC	90 mins
	M		2	I	
	12 W - 735 lm		0-10 Fade-off	IC	
	H		D	A	
	18 W - 990 lm		DALI	Airtight	
	Dim to Warm:		P	0	No Housing
	W		Phase ELV & Triac		
	10 W - 610 lm		L		
	D		Lutron		
	18 W - 1190 lm		X		
	Tunable White:		DMX		
	U				
	10 W - 540 lm				
	A				
	18 W - 740 lm				
	RGBW:				
	C				
	4 W - 360 lm				

Module Code :

Code Example: C4MR0NLWWDZ927MT

Fill in the same power code value for the housing and module.

C4MR0N	Power	Body Finish	Baffles Finish	UL Rating	Optics Type	CRI	CCT	Accessory	Accessory (secondary)
C4MR0N	Mono:	W	W	D	Z	9	27	O	N
	L	White	Flat White	Dry	15°-50°	90+	2700K	None	None
	U								
	10 W - 530 lm	B	Flat Black	Wet		Thrive	3000K	Clear Lens	Clear Lens
	M	G	N				35	D	L
	12 W - 735 lm	Grey	Black Nickel				3500K	Diffuse Lens	Diffuse Lens
	H	X	C				40	E	F
	18 W - 990 lm	Custom	Specular Chrome				4000K	Elliptical Lens	Solite Lens
	Dim to Warm:		D				WD		
	W		Diffuse Chrome				3000K - 1800K	H	
	10 W - 610 lm		G				TW	Honeycomb Lens	
	D		Bright Gold				2700K - 6500K	S	
	18 W - 1190 lm		E				CC	Solite Lens	
	Tunable White:		Diffuse Gold				RGBW	M	
	U							Mixing	
	10 W - 540 lm								
	A								
	18 W - 740 lm								
	RGBW:								
	C								
	4 W - 360 lm								

- Notes:**
1. Denotes output at 3000K, unless otherwise noted.
 2. Denotes output specific to Dim-to-Warm at 3000K.
 3. Denotes output specific to Tunable White.
 4. Denotes output specific to RGBW.
 5. Not applicable for ELV dimming.
 6. Hi-lume, Vive, and Athena compatible.
 7. Only available with DMX dimming.
 8. Not applicable for integral driver.



Optical Flexibility:

HAMELEON R4 PINHOLE ADJUSTABLE ZOOMABLE DISTRIBUTION 15°

Zoomable Distribution 15°

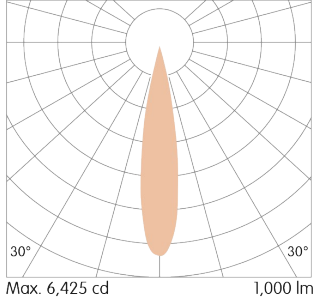

HAMELEON R4 PINHOLE ADJUSTABLE ZOOMABLE DISTRIBUTION 50°

Zoomable Distribution 50°

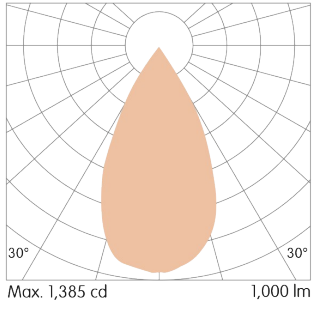

BEAM DISTRIBUTION AND COMBINATION

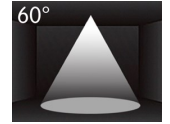
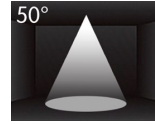
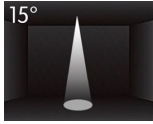
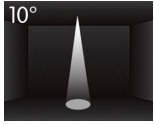

10°+ Diffuse lens

25°+ Diffuse lens

50°+ Diffuse lens

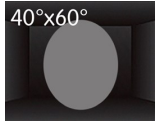
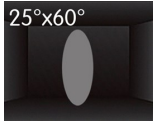
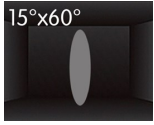

10°+ Elliptical spread lens (10x60)

25°+ Elliptical spread lens (10x60)

35°+ Elliptical spread lens (10x60)

Delivered Lumen Output:

Output		Watts		CRI +90			
STATIC-WHITE				2700K	3000K	4000K	
L	10W			505 lm	530 lm	550 lm	
M	12W			705 lm	735 lm	765 lm	
H	18W			945 lm	990 lm	1025 lm	
DIM-TO-WARM 3000K-3000K					3000K		
W	10W				610 lm		
D	18W				1190 lm		
TUNABLE WHITE 2700K-6500K				2700K		6500K	
U	10W			540 lm		640 lm	
A	18W			740 lm		900 lm	
RGBW				R	G	B	W
Total	4W			50 lm	360 lm	60 lm	240 lm

Mounting Flexibility:

TRIMLESS



Max Ceiling Thickness 1 1/4"

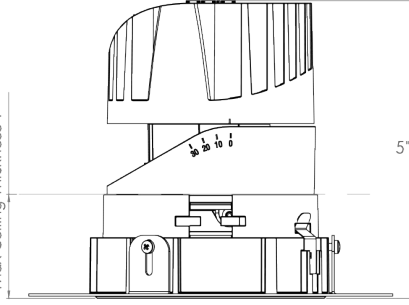

4 1/4" x 4 1/4"

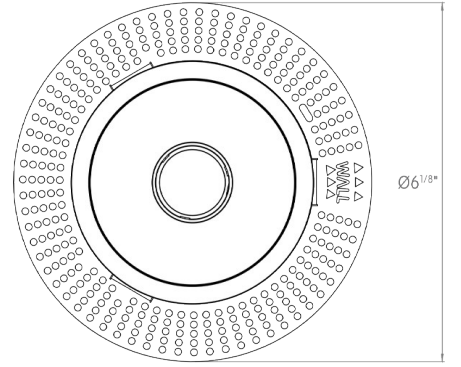

Housing:

REMODEL HOUSING

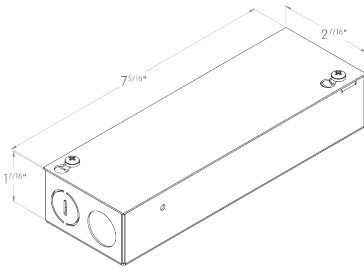

- Ceilings Without Insulation.
- You Want Higher Wattage Fixtures.
- When There's At Least 3 Inches Clearance Around Fixture.

NON-IC HOUSING

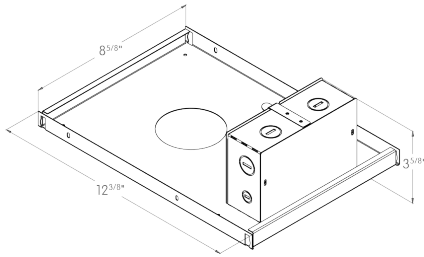

- Ceilings Without Insulation.
- You Want Higher Wattage Fixtures.
- When There's At Least 3 Inches Clearance Around Fixture.

IC HOUSING & AIRTIGHT

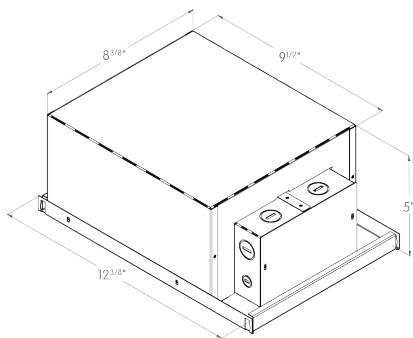

- If There Is Insulation in the Ceiling.
- In Residential Ceilings or Attics.
- In Energy-Efficient or Sealed Homes.